

Pfaff 439
Subclass

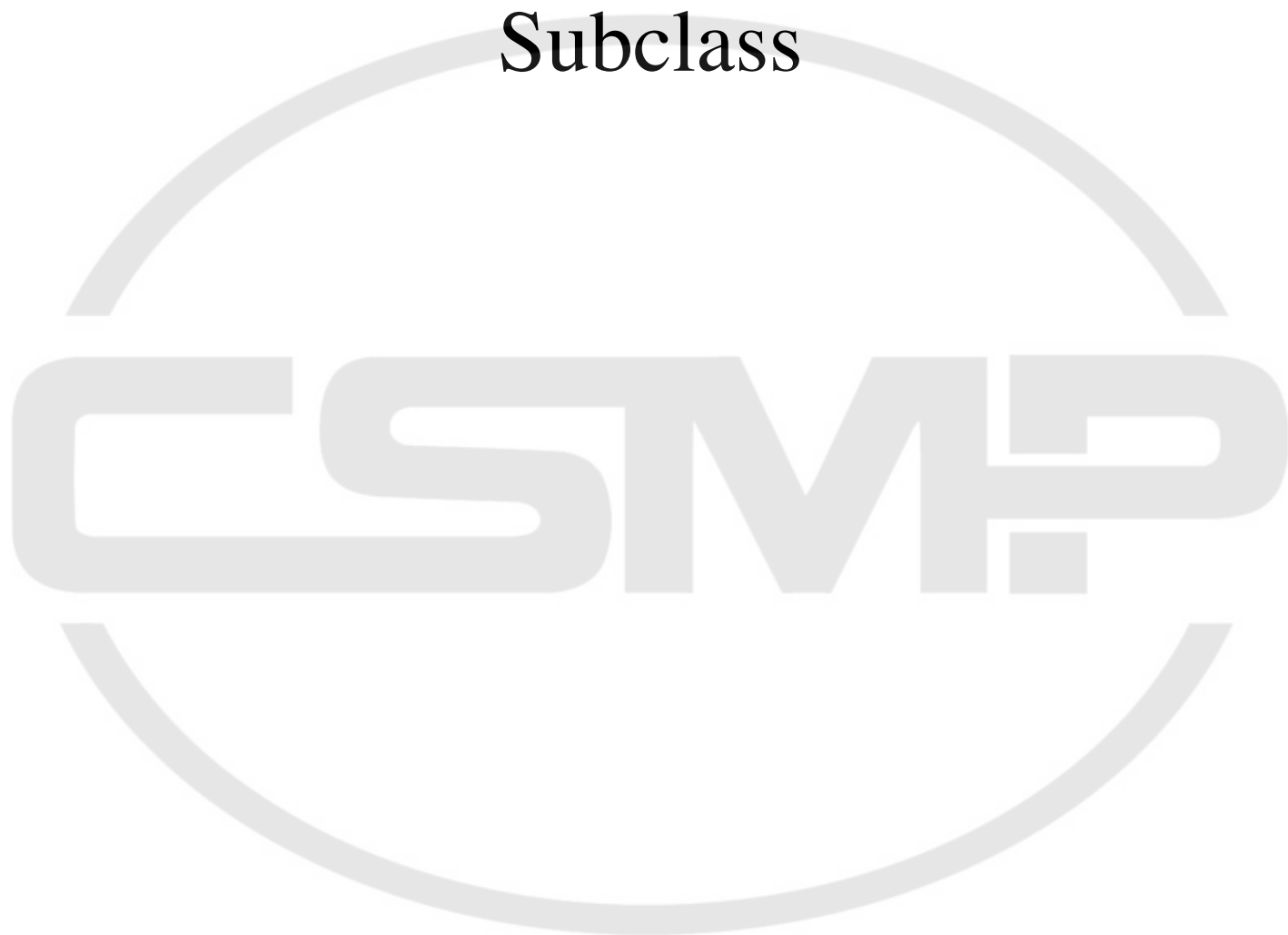

PFAFF

439

Unterklassen-Ausstattung

Subclass parts

Composition des sous-classes

Composición de las subclases

CSMP



Table of subclasses
Table des sous-classes
Tabla de subclases

PFAFF 439







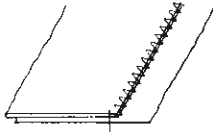
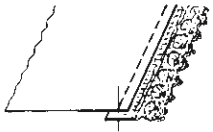
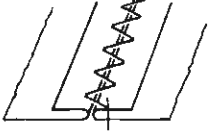

Unterklasse Subclass Sous-classe Subclase	-6/01 (-900/..)	-32/23 (-900/..)	-34/01 (-900/..)	-34/01 (-900/..)
Arbeitsgang Operation Opération Opéracion	Für allgemeine Näharbeiten. Standardform des Teilesatzes. For ordinary sewing operations. Standard parts set. Travaux d'utilité courante. Jeu de pièces standard. Para trabajos de costura en general. Juego de piezas estándar.		Zum Nähen feiner Materialien. Standardform des Teilesatzes. For sewing light fabrics. Standard parts set. Pour la couture de matières fines. Jeu de pièces standard. Para coser materiales finos. Juego de piezas estándar.	Zum Nähen feiner Materialien. Standardform des Teilesatzes. For sewing light fabrics. Standard parts set. Pour la couture de matières fines. Jeu de pièces standard. Para coser materiales finos. Juego de piezas estándar.
Ausführung Model Version Tipo de máquina	AB	BN 24	AN 24; BN 24	AB
Nadelabstand in mm Needle gauge in mm Ecartement des aiguilles en mm Distancia entre agujas en mm	6,0	6,0	3,0	4,5
Nadelstange Needle bar Barre à aiguille Barra de aguja	91-168 019-91	91-168 019-91	91-168 019-91	91-168 019-91
Nähfuß ⁴ Presser foot Pied presseur Pie prensatejas	91-054 695-23	91-157 299-93	91-055 170-23	91-055 311-23
Stichplatte ⁴ Needle plate Plaque à aiguille Placa de aguja	91-058 034-04	91-058 113-24	91-058 140-24	91-058 211-24
Stoffschieber ⁴ Feed dog Griffe Transportador inferior	91-047 381-03	91-047 746-03	91-047 700-03	91-047 729-03
Apparat ⁵ Attachment Appareil Aparato		91-047 946-25		
Träger Bracket Support Soporte		91-753 936-25		

Table of subclasses
Table des sous-classes
Tabla de subclases

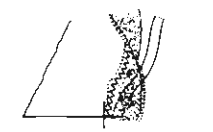
PFAFF 439

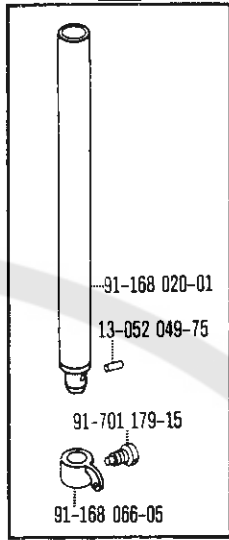
Unterklasse Subclass Sous-classe Subclase	-65/23 (-900/..)	-72/03 (-900/..)	-305/02 (-900/..)	-771/04-6/27 (-900/..)	-771/04-280/06 (-900/..)
Arbeitsgang Operation Opération Operación					
Ausführung Model Version Tipo de máquina	BN 24	AB	AB	AN 13	AN 13
Nadelabstand in mm Needle gauge in mm Ecartement des aiguilles en mm Distancia entre agujas en mm	6,0	6,0	6,0	3,0	3,0
Nadelstange Needle bar Barre à aiguille Barra de aguja	91-168 019-91	91-168 019-91	91-168 019-91	91-168 019-91	91-168 019-91
Nähfuß [4] Presser foot Pied presseur Pie prensateelas	91-155 264-91	91-055 029-23	91-055 110-23	91-155 954-03	91-154 195-91
Stichplatte [4] Needle plate Plaque à aiguille Placa de aguja	91-058 113-24	91-058 035-24	91-058 035-24	91-150 168-93	91-150 168-93
Stoffschieber [4] Feed dog Griffe Transportador interior	91-047 746-03	91-047 613-03	91-047 378-03	91-059 787-03	91-059 787-03
Apparat [5] Attachment Appareil Aparato			91-056 730-23		
Träger Bracket Support Soporte			91-056 731-05		

<p>91-054 695-03 4</p>  <p style="text-align: right;">-6/01 (-900/..)</p>	<p style="text-align: center;">91-168 019-91</p>  <p style="text-align: right;">-6/01 (-900/..) -32/23 (-900/..) -34/01 (-900/..) -72/03 (-900/..) -305/02 (-900/..) -771/04-6/27 (-900/..) -771/04-280/06 (-900/..)</p>		
<p>91-055 029-04 4</p>  <p style="text-align: right;">-72/03 (-900/..)</p>	<p style="text-align: center;">91-055 110-03 4</p> 3.1." data-bbox="405 525 535 610"/> <p style="text-align: right;">-305/02 (-900/..)</p>	<p>91-055 170-03 4</p>  <p style="text-align: right;">-34/01 (-900/..)</p>	<p>91-055 311-03 4</p>  <p style="text-align: right;">-34/01 (-900/..)</p>
<p style="text-align: center;">91-154 195-91 4</p> 3.1." data-bbox="205 755 355 855"/> <p style="text-align: right;">-771/04-280/06 (-900/..)</p>	<p style="text-align: center;">91-155 264-91 4</p> 3.1." data-bbox="395 755 555 855"/> <p style="text-align: right;">-65/23 (-900/..)</p>	<p style="text-align: center;">91-155 954-04 4</p> 3.1." data-bbox="595 755 735 855"/> <p style="text-align: right;">-771/04-6/27 (-900/..)</p>	<p style="text-align: center;">91-157 299-93 4</p> 3.1." data-bbox="775 755 945 855"/> <p style="text-align: right;">-32/23 (-900/..)</p>

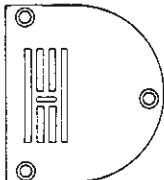
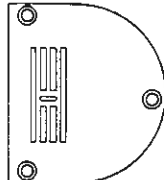
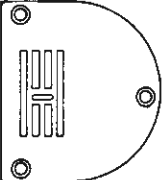
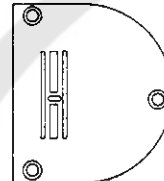
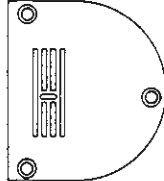
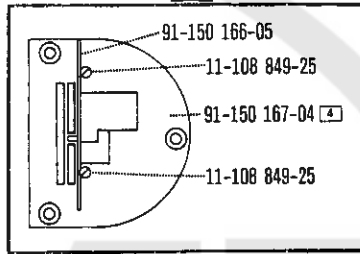
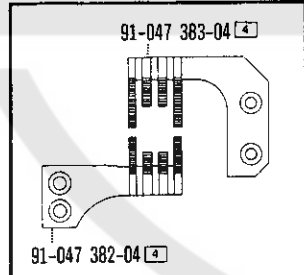
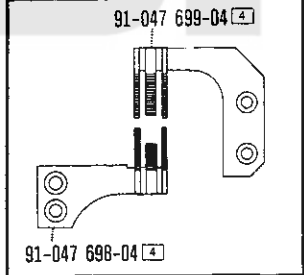
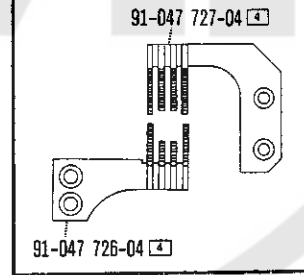
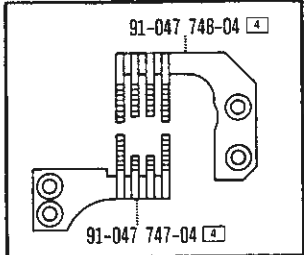
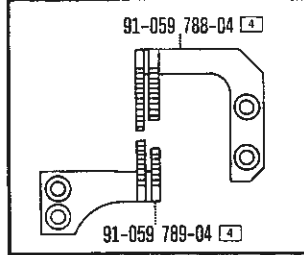
<p>91-058 034-04 </p>  <p>-6/01 (-900/..)</p>	<p>91-058 035-04 </p>  <p>-72/03 (-900/..) -305/02 (-900/..)</p>	<p>91-058 113-04 </p>  <p>-32/23 (-900/..) -65/23 (-900/..)</p>
<p>91-058 140-04 </p>  <p>-34/01 (-900/..)</p>	<p>91-058 211-04 </p>  <p>-34/01 (-900/..)</p>	<p>91-150 168-93 </p>  <p>-771/04-6/27 (-900/..) -771/04-280/06 (-900/..)</p>
<p>91-047 381-03 </p>  <p>-6/01 (-900/..)</p>	<p>91-047 700-03 </p>  <p>-34/01 (-900/..)</p>	<p>91-047 729-03 </p>  <p>-34/01 (-900/..)</p>
<p>91-047 746-03 </p>  <p>-32/23 (-900/..) -65/23 (-900/..)</p>	<p>91-059 787-03 </p>  <p>-771/04-6/27 (-900/..) -771/04-280/06 (-900/..)</p>	

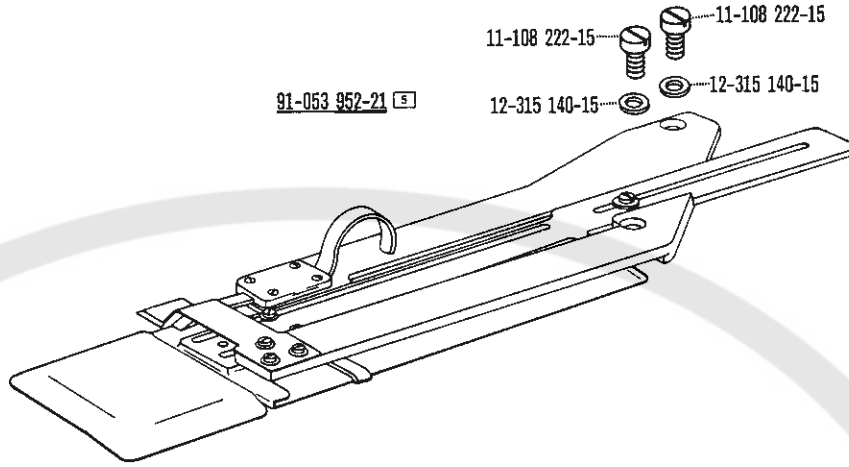

-72/03 (-900/..)

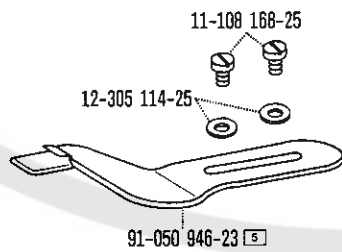

-32/23 (-900/..)

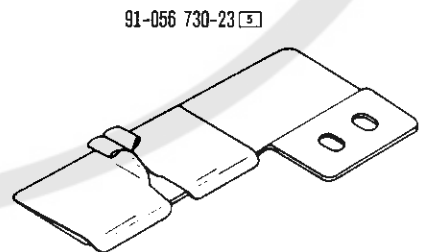

-305/02 (-900/..)

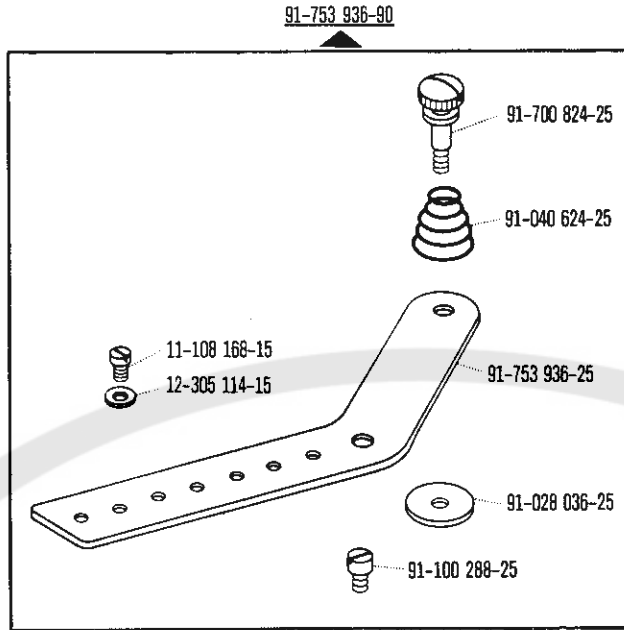

-32/23 (-900/..)
 -305/02 (-900/..)

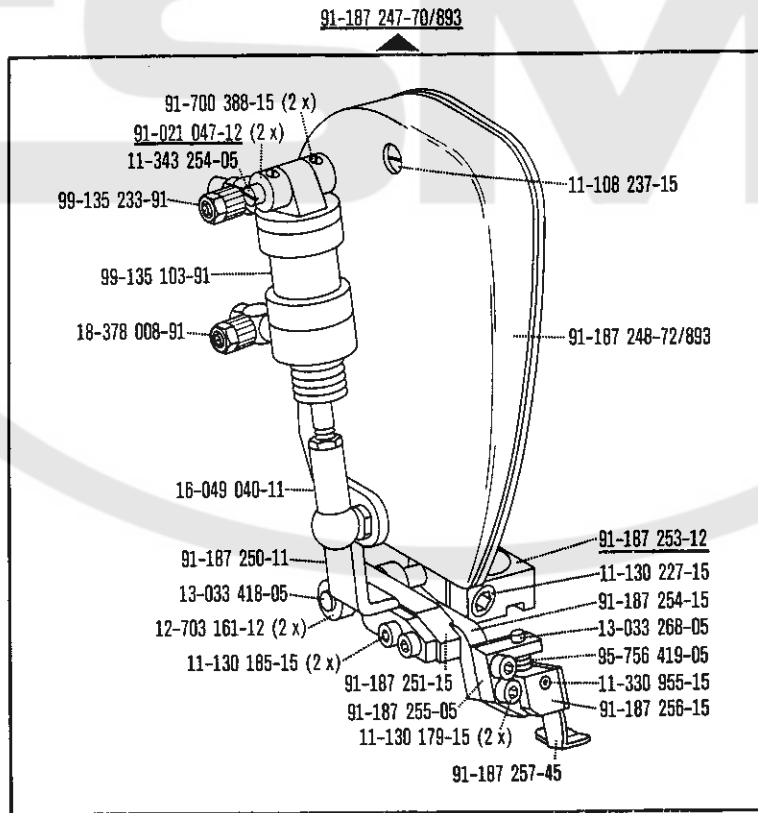

-771/04-280/06 (-900/..)

☐ siehe Erläuterungen Register
 see explanations in section
 voir légende registre